

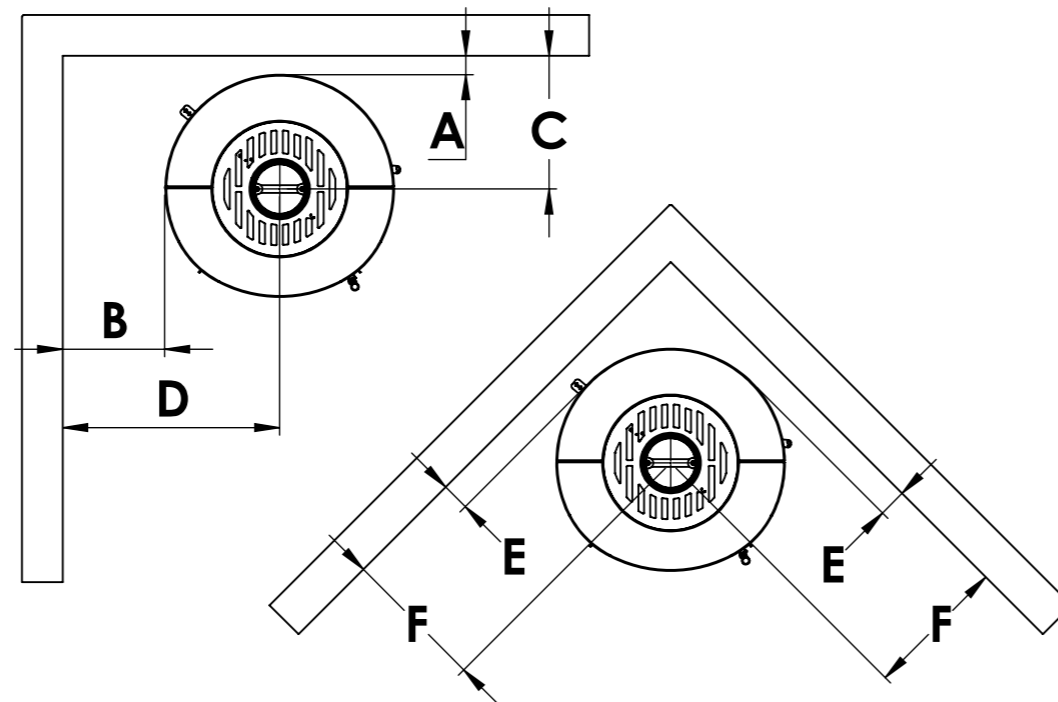

Serie	Scan-Line 80
Description	Scan-Line 80XLB

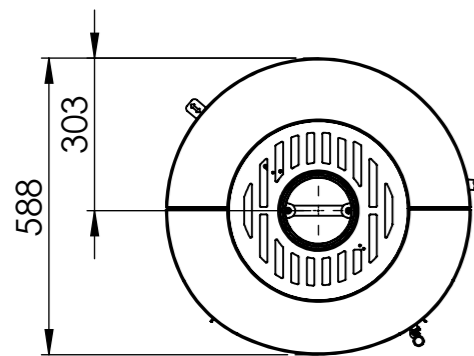
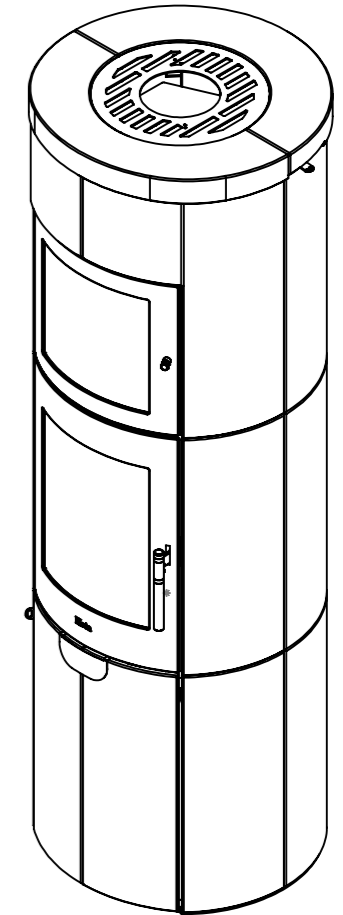
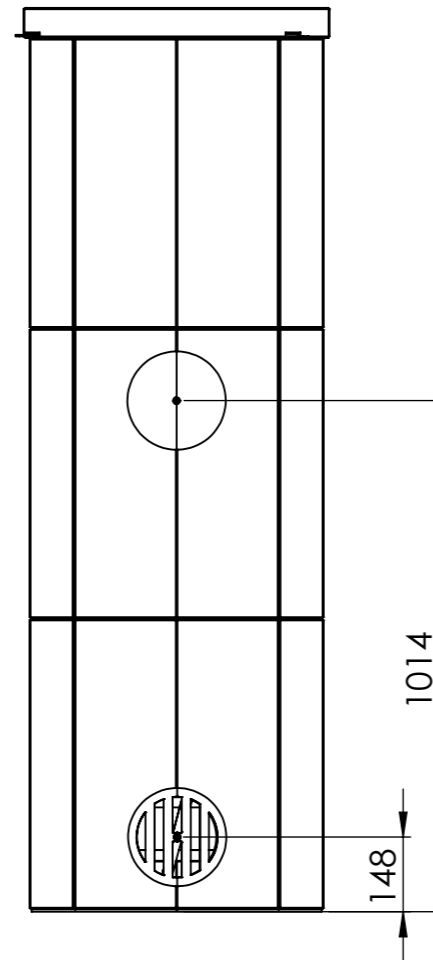
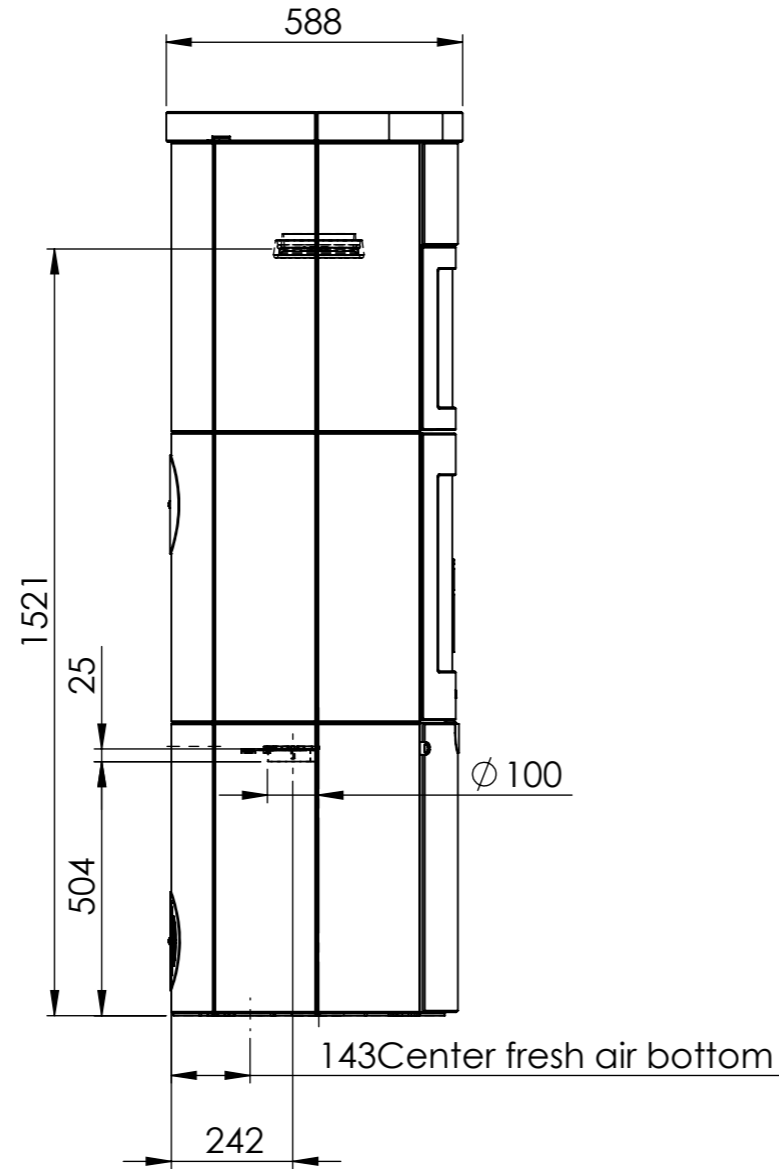
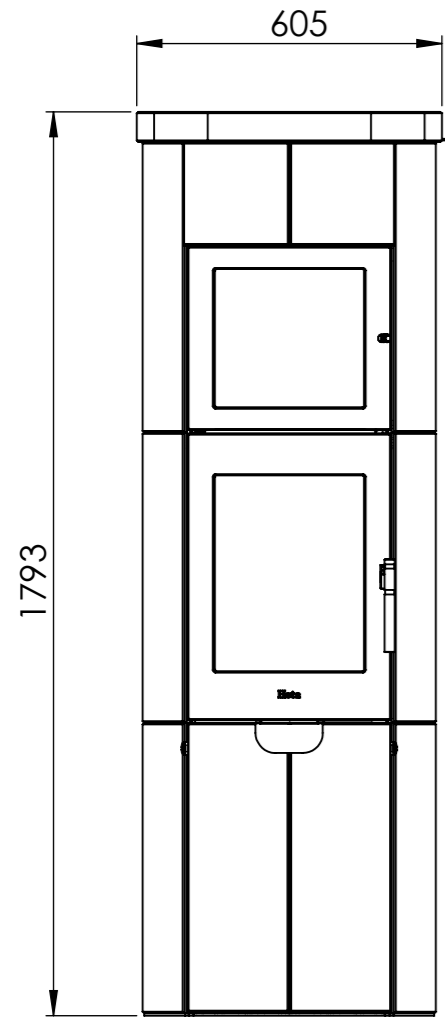

Information on Minimum distance

EN: If Heta's minimum distance to combustibles is used. The installation must always be approved by the local authorities (chimney sweep) before starting installation of the stove.

DK: Hvis minimumsafstand til brændbart anvendes, skal dette altid godkendes af de lokale myndigheder (skorstensfejer) inden montage af ovnen påbegyndes.

DE: Wenn sie den Mindestabstand zu brennbaren Material nutzen möchten, muss dies immer von den örtlichen Behörden (Schornsteinfeger) genehmigt werden, bevor mit der Installation des Ofens begonnen wird.

	Minimum distances #	Distance according to EN 13240
A	50	125
B	270	300
C	352	428
D	574	603
E	74	125
F	376	428